

Manual

Classic P3

1 Quadrant Thyristor Drive

Part 1 Thyristor Drive
Part 2 Analogue Control Electronics

P3x/x-240...840A
REG4

UNITEK

Industrie Elektronik
G m b H

Hans-Paul-Kaysser-Strasse 1
D-71397 Leutenbach 3 - Nellmersbach

Tel.: 07195/9283-0
Fax 07195/928329
email info@unitek-online.de
Http:// www.unitek-online.de

Edition
0910

Contents	Page
1. Basic Information	
Safety advice	3
Standards and guidelines	3
General information	4
Features	5
Technical data	6, 7
Specification	8
2. Mechanical installation	9
Dimensions	10, 11
3. Electrical installation	
Connections	12
Connection diagram	13
CE advice	14
Power supply	15, 16
Option - synchronization	17
Motor connection	19
Field connections	20
Actual value connection	21
Components	22
Adjustments	22
Circuit diagram	23
Current control loop	24
Signals	25
Measurements	25
4. Commissioning + REG4	26, 27
5. Faults	28, 29
6. Guarantee	30
7. Protocol	31, 32
8. Drawings	
Dimensions (P3 240-360A)	33
Dimensions (P3 480-840A)	34

Note: For the commissioning and the error diagnosis please refer to the manuals Q..., P...!
Observe any cross-references!



1 Basic - Information

Electronic equipment is not fault proof. This fact should be borne in mind for all possible operating conditions.

ATTENTION - High voltage

500V~ac, 650V=dc

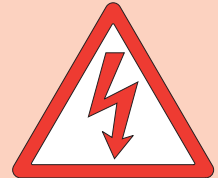

Before installation or commissioning begins, this manual must be thoroughly read and understood by the technical staff involved.

If any uncertainty arises, the manufacturer or dealer should be contacted.

P3 devices are power electric parts used for regulating energy flow.

Protection rating IP00.

Standards and guidelines

The device and its associated components can only be installed and switched on where the local regulations and technical standards have been strictly adhered to:

EU Guidelines	89/392/EWG, 84/528/EWG, 86/663/EWG, 72/23/EWG EN60204, EN50178, EN60439-1, EN60146, EN61800-3
IEC/UL	IEC364, IEC 664, UL508C, UL840
VDE Regulations	VDE100, VDE110, VDE160
TÜV Regulations	
Trade body guidelines	VGB4

The user must ensure that in the event of:

- device failure
- incorrect operation
- loss of regulation or control

the axis will be safely de-activated.

It must also be ensured that the machine or equipment are fitted with device independent monitoring and safety features.

Setting adjustments

- should only be carried out by suitably trained personnel
- should only be carried out in accordance with health and safety guidelines

Assembly

- should only be carried out when all voltages have been removed.

QS

Test results are archived with the device serial number by the manufacturer.

CE

The device adheres to the following: Guideline EU 89/336/EWG. EMC standards EN61000-2 and EN61000-4.

Attention

This manual P3 only describes the basic control unit.



P3

This device description must be read in conjunction with the manual for

- an analogue control REG xx
- an internal field control Q3-F
- an external field control F2
- options Multi

General information

Series Classic P3

1 Basic - Information

Build

- switch cabinet mounting
- according to the VDE, DIN and EU regulations
- standard control electronics REG
- intrinsically safe power section with current control loop
- controlled or uncontrolled field supply unit
- optional units

Galvanic isolation between

- the power section and the housing
- the power section and the control electronics

The distance of air gaps and leakage paths adhere to the VDE standards (>8mm).

Components

- fully insulated thyristor modules, comfortably over-dimensioned
- only components customary in trade and industrially standardised are used
- high-quality bases for the IC with external connections
- LED displays
- precision potentiometers for fine adjustments
- plug-in jumpers for the system set-up

Characteristics

- * Series Klassik P3
- * Thyristor drive for dc motors
- * Power range 108kW to 378kW
- * Drive in 1 quadrant
- * Energy recovery
- * Intrinsically safe power section
- * Fast analogue current control
- * Temperature watchdog - power section
- * Controlled or uncontrolled field rectifier
- * 26-pin interface
- * Features of the control electronics:
see Manual REGxx or third-party product documentation
- * Optional units

Classic P3 x/x - 240-840A

P3 400/450-x			
Power connection Auxiliary voltage connection Output voltage Cooling		360 ... 440V~ 360 ... 440V~ or 200...250V~ max. +450V= ventilation fan	
P3 400/450-		240	360
Input current	A~	192	288
Output current	peak 5 s. continuous	A= A=	480 240
			720 360
El. power	kW	108	162
Fuses	ff	installed	installed
- input 3 pcs.	AFF	250	315
- field	AF	10	10
Power chokes	Type mH	1x KD5-250 0.12	3x K 170-400 0.08
Armature chokes Armature chokes are necessary only for special applications.	Type mH	UI180B250 2.2	UI210C400 1.8
Dimensions w _x h _x d	mm	305x510x240	305x510x240
Weight	kg	23	23

P3 500/550-x			
Power connection Auxiliary voltage Output voltage connection Cooling		450 ... 550V~ 360 ... 440V~ or 200 ... 250V~ max. +550V= ventilation fan	
P3 500/550-		240	360
Input current	A~	192	288
Output current	- peak - continuous	A= A=	480 240
			720 360
El. power	kW	132	198
Fuses	ff	installed	installed
- input 3 pcs.	AFF	250	315
- field	AF	10	10
Power chokes	Type mH	1x KD5-250 0.12	3x K 170-400 0.08
Armature chokes Armature chokes are necessary only for special applications.	Type mH	UI180B250 2.2	UI210C400 1.8
Dimensions w _x h _x d	mm	305x510x240	305x510x240
Weight	kg	23	23

1 Basic - Information

P3 400/450-x			
Power connection' Auxiliary voltage connection Output connection cooling		360 ... 440V~ 360 ... 440V~ or 200...250V~ max. +450V= ventilation fan	
Gerät P3 400/450-		480	840
Input current	A~	384	672
Output current			
- peak	A=	960	1680
- continuous	A=	480	840
El. power	kW	216	378
Fuses	ff	installed	installed
- input 3 pcs.	AFF	400	500
- field	AF	10	10
Power chokes	Typ mH	3x KU150-600 0.06	3x KU150-800 0.04
Armature chokes Armature chokes are necessary only for special applications.	Typ mH	UI240C500 1.6	UI240-700 1.2
Dimensions wxhxd	mm	405x560x240	486.5x560x240
Weight	kg	36	40.8

P3 500/550-x			
Power connections Auxiliary voltage connections Output voltage Cooling		450 ... 550V~ 360 ... 440V~ or 200...250V~ max. +550V= ventilation fan	
P3 500/550-		480	840
Input current	A~	384	672
Output current			
- peak	A=	960	1680
- continuous	A=	480	840
El. power	kW	264	462
Fuses	ff	installed	installed
- input 3pcs.	AFF	400	500
- field	AF	10	10
Power chokes	Type mH	3x KU150-600 0.06	3x KU150-800 0.04
Armature chokes armature chokes are necessary only for special applications.	Type mH	UI240C500 1.6	UI240-700 1.2
Dimensions wxhxd	mm	405x560x240	486.5x560x240
Weight	kg	36	40.8

Specification

Mains frequency	50 or 60Hz $\pm 5\%$
Protection rating	IP 00
Format	VDE 0100 group C, VDE 0160
Humidity rating	class F acc. to DIN 40040
Site of installation	< 1000m above sea level
Operating temperature range	0 ... 45°C
Extended operating temp. Range	up to 60°C reduced by 2%/°C
Storage temperature range	-30°C to + 80°C

Current control loop circuit

Amplification

- input signal	0 to $\pm 10V=$
- output	0 to $\pm 200\%$ type current
Over-current limiting	10s 200% type current
Control precision	$\pm 2\%$
Control range	1:50
Enable	> +10V

Speed control loop circuit (with manual REG)

Control precision (without actual value error)	< $\pm 0.1\%$
Control range	> 1:1000

Interface control electronics X3

Function		Connector no.
+ 24V	$\pm 10\%$	X3: 1 and 2
+ 15V	$\pm 2\%$	X3: 3 and 4
- 24V	$\pm 10\%$	X3: 5 and 6
- 15V	$\pm 2\%$	X3: 7 and 8
Device GND	0	X3: 9, 10, 11, 12, 13, 14
I command value (GND)	0	X3: 15
I command value (signal)	+10V=	X3: 16
Current controller enable	+10V=	X3: 17
Drive disable 1	+10V=	X3: 18
Drive disable 2	+10V=	X3: 19
N (speed) actual	+10V=	X3: 20
I (current) actual	+5V=	X3: 21
Over-current power section	+10V=	X3: 22
Option U	$\pm 10V=$	X3: 23
Option U	0-10V=	X3: 24
Drive ready BTB	+10V=	X3: 25
	+5V	X3: 26

2 Mechanical Installation

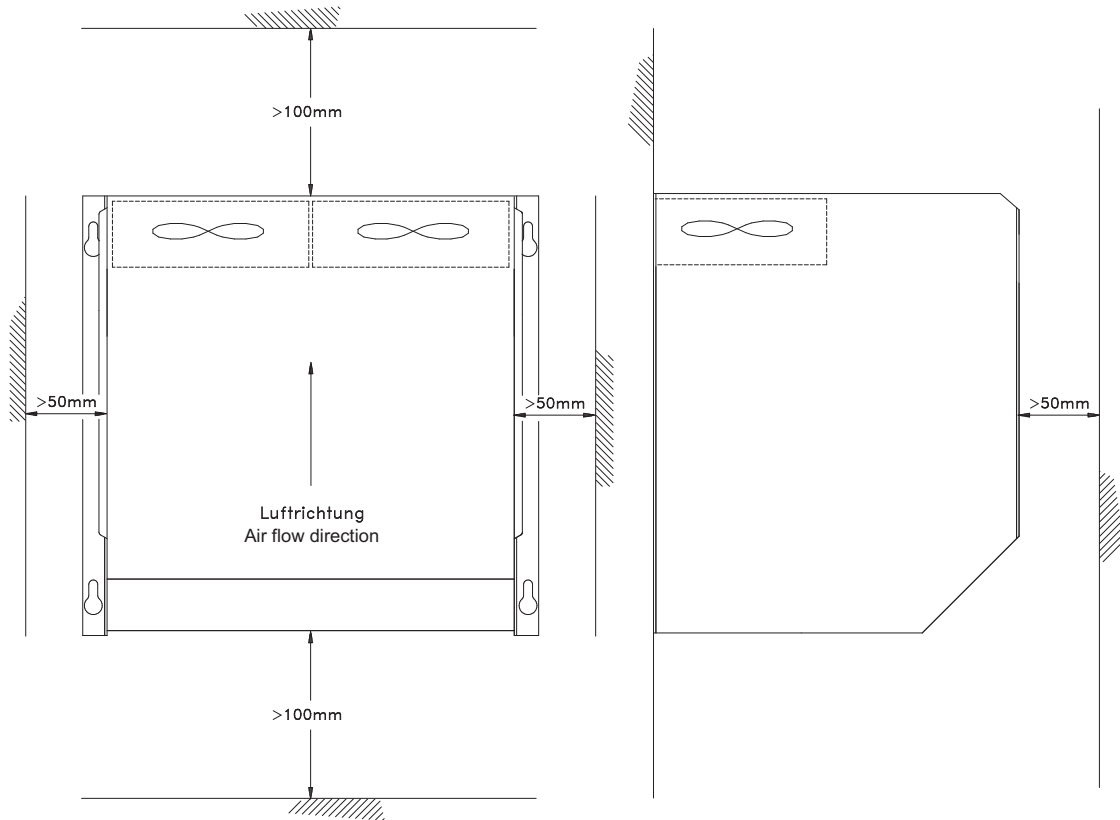

Ambient temperature
max. Cooling unit temperature **80°C**

0 bis <45°C (reduced, up to 60°C)
(internal watchdog)

Air-mass throughput	240A	680m³h
	360A	680m³h
	480A	820m³h
	840A	820m³h

Dissipation loss with max. power		
Unit P3-x/x-	Unit W	Mains choke W
240A-	1000	260
360A-	1440	330
480A-	1890	400
840A-	3060	780

Classic P3 x/x - 240-840A

Dimensions

P3 240/360A

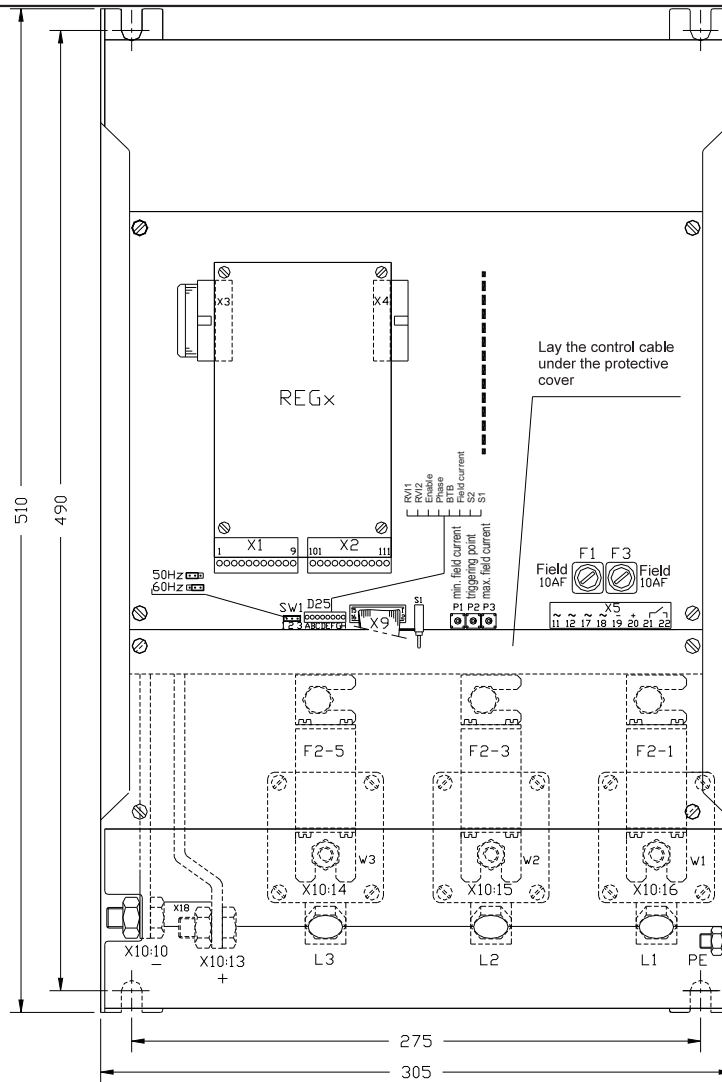

Three-phase power choke
up to 250A

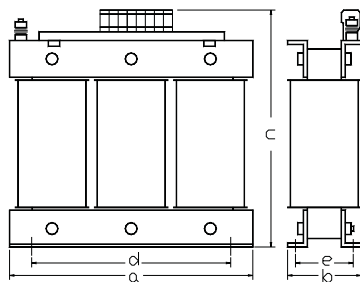

single -phase mains choke
from 360A

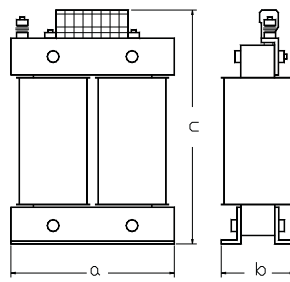

Features

UN 400V~50/60Hz
 Uk 4%
 Protection rating IP00
 isol. Class T40/E
 vertical angle bracket

Unit P3-Type	Choke	L mH	PV W	Dimensions					Weight kg	Screw M
				a	b	c	d	e		
240A	KD5-250	0.12	260	300	170	270	200	100	31.5	8
360A	K170-400	0.08	330	142	170	230	106	88	14	8
480A	KU150-60 0	0.06	400	210	260	275	100	108	29	8
660A	KU150-60 0	0.06	610	210	260	275	100	108	29	8
840A	KU150-80 0	0.04	780	210	270	275	100	108	31	8

with filter: KDF xx

2 Mechanical Installation

P3 840A

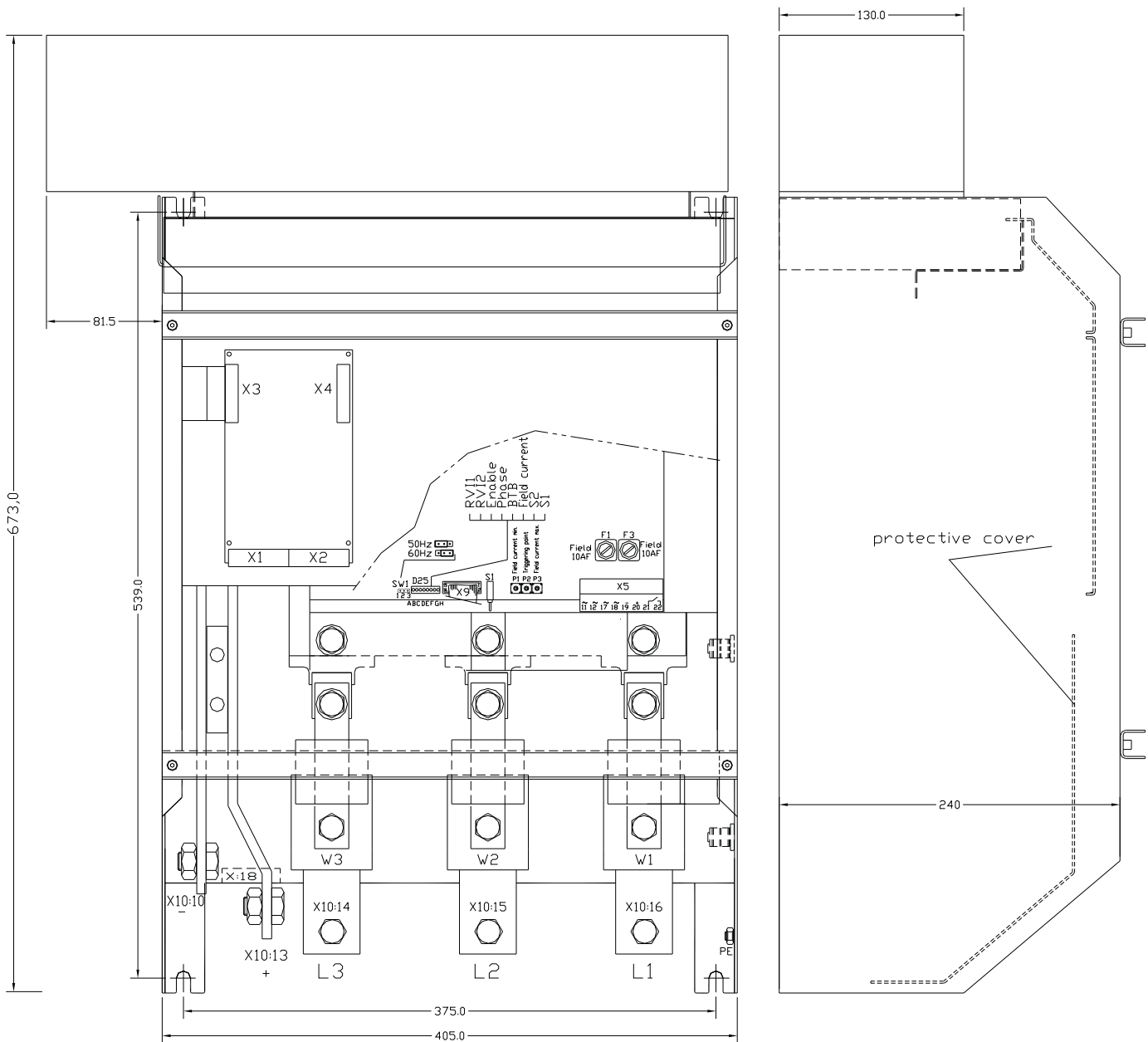

Dimensions

Dimensions P3 240-840A					
Unit P3-x/x-	Width mm	Height mm	Depth mm	Drill hole mm	Weight kg
240A	305	510	240	275 x 490	23
360A	305	510	240	275 x 490	23
480A	405	560	240	375 x 540	36
660A	405	560	240	375 x 540	36
840A	486.5	673	240	375 x 540	40.8

Fixing screw M8

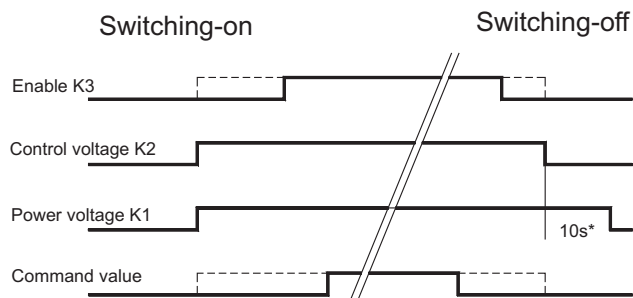
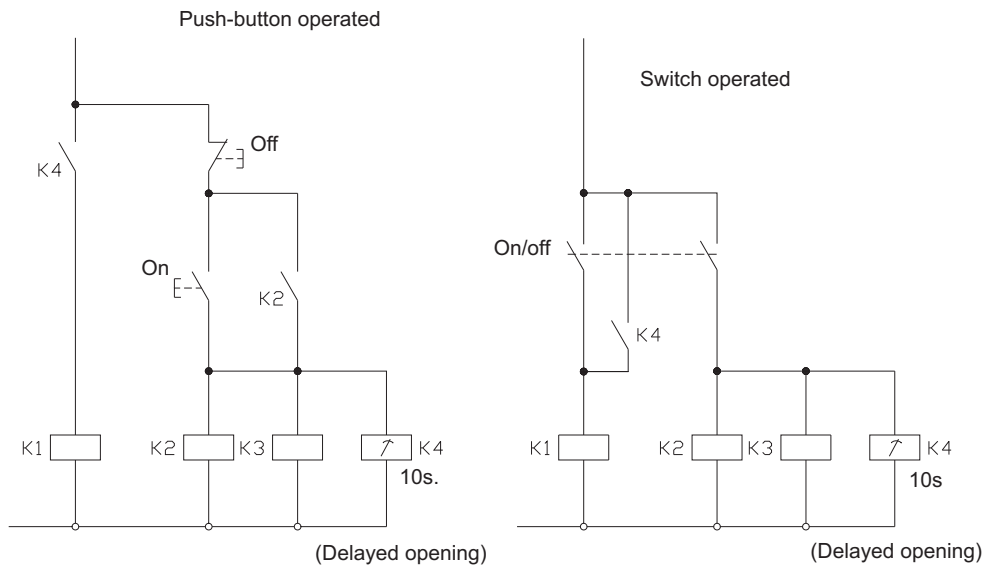
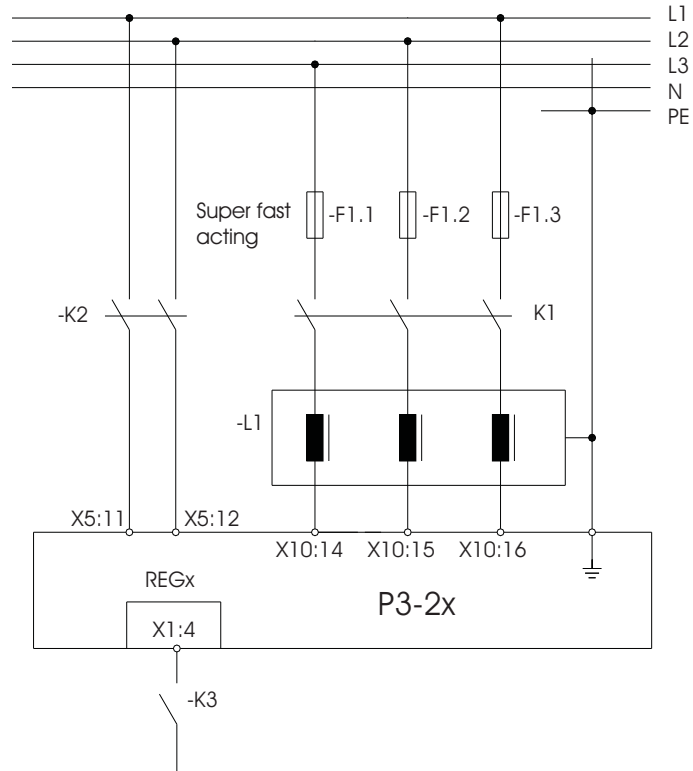

* Switch-off delay stand still 0.3s

3 Electrical Installation

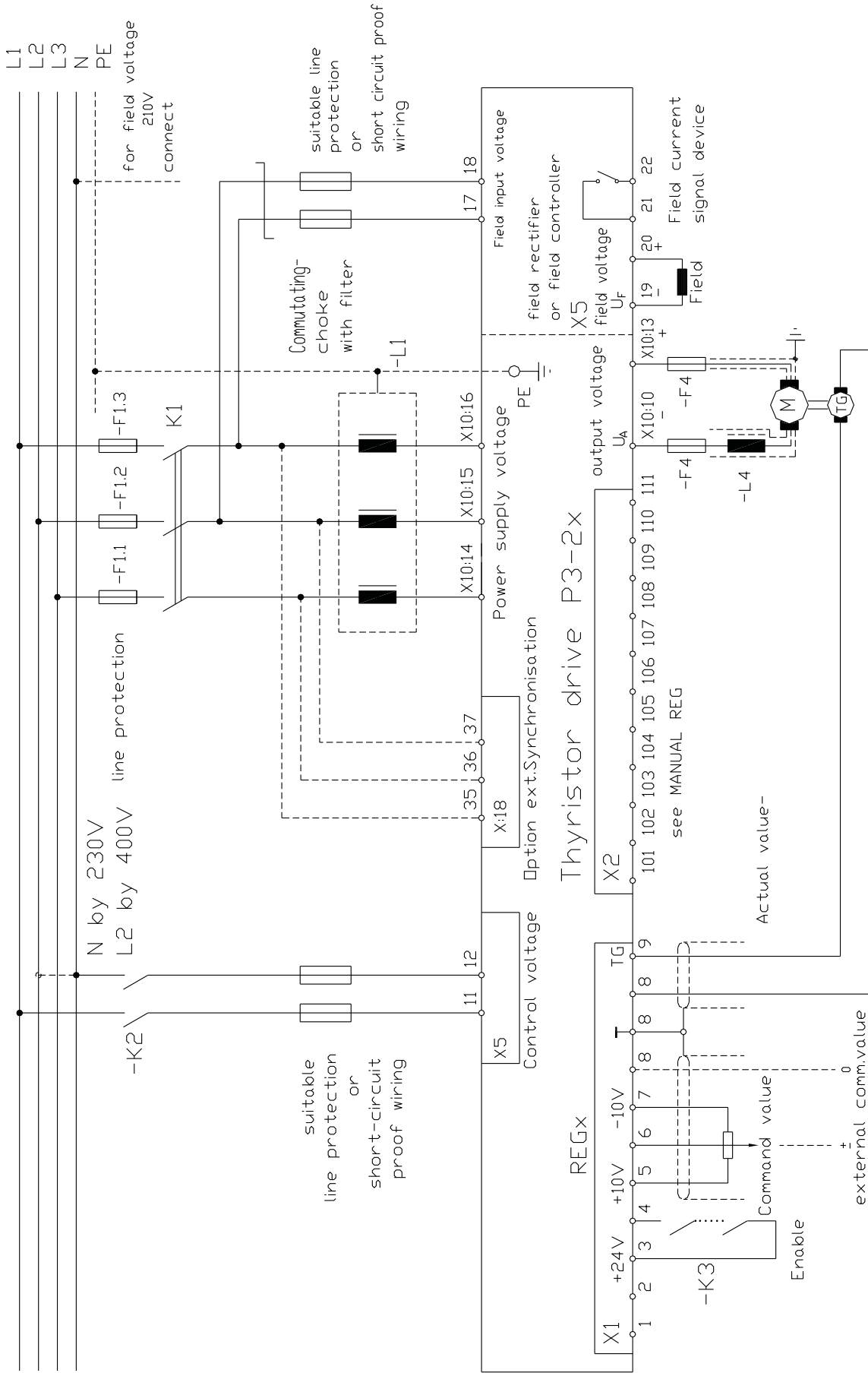

For EMC: All control lines have to be shielded
 Motor- and field lines have to be shielded

Classic P3 x/x - 240-840A

The devices adhere to the EU guidelines 89/336/EWG and the technical standards EN 61000-2 and 61000-4 provided that the following conditions are observed:

- The device, the transformer, and filter capacitors are mounted on a 500x500x2 mm mounting plate.
- The mounting plate must be connected to ground using a 10mm² wire.
- The motor housing must be connected to ground using a 10mm² wire.
- The device ground X1:8 must be connected to the mounting plate using a 2.5mm² wire.
- Device PE screw must be connected to the mounting plate using a 4mm² wire, l = 50mm.

Three-phase connection:

Power choke type: see technical details
 Filter capacitors: 3 x 0.5µF/600V~ 3 x 1µF (x) + 1 x 0.5µF (y)
 Conductor length between the device and the power choke <250mm

Motor connection:

Motor conductors l = 1.5m, shielded
 Tacho and all control lines l = 1.5m, shielded
 Shielding connected to PE

Earthing diagram

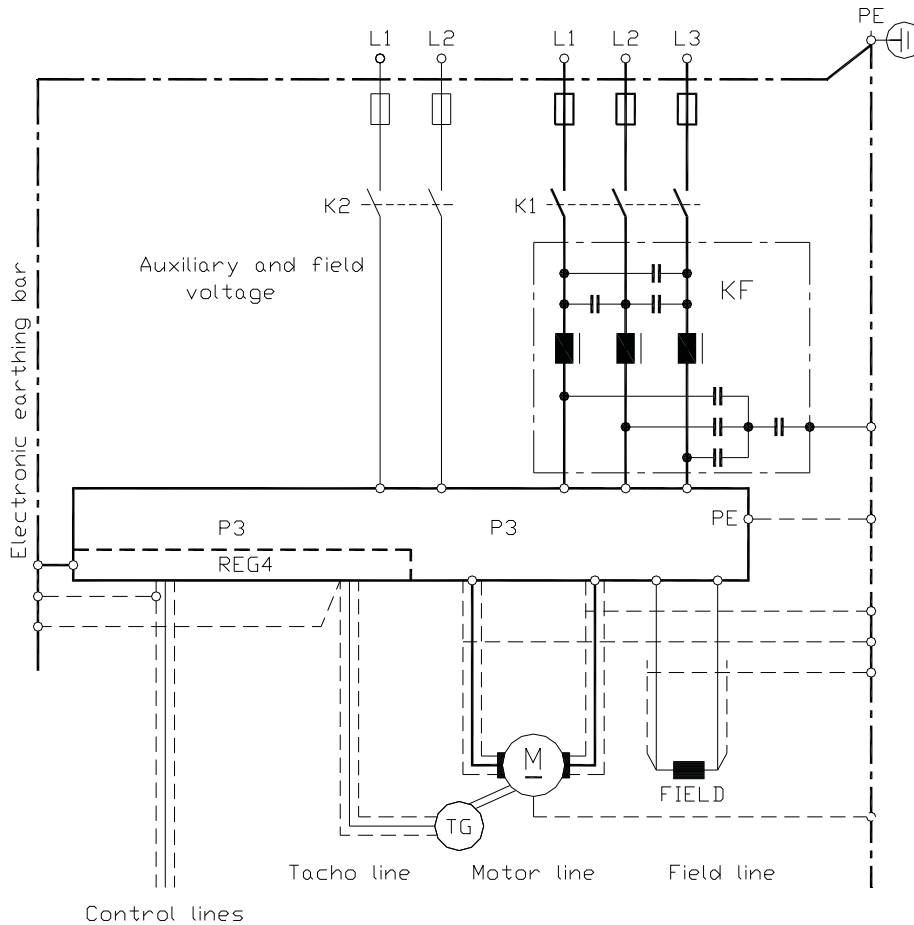

KF = Commutation choke with filter capacitors

3 Electrical installation

Attention:

The order of the connections to the connector numbers or screw terminals is obligatory. All further advice is non-obligatory.

The input and output conductors may be altered or supplemented in accordance with the electrical standards.

Note:

- Connection and operating instructions
- Local regulations
- EU guideline 89/392/EWG
- VDE and TÜV regulations and Trade body guidelines



Switch on the auxiliary voltage and the supply voltage simultaneously.
Switch off the supply voltage after the auxiliary voltage

Input filter

see CE advice, page 14

Short conductor length to be used between the input filter and the device

Auxiliary voltage connection

Connection	terminal X5:11, X5:12
Power supply	400V~ ±15%
Special voltages	24V~, 110V~, 230V~, 500V~
Input current	max. 300mA
Phase position	regardless
Internal fuses	FE1, FE2 0.8AT

- Min. line cross-section 0.5mm²
- External fuse
- Min. line protection 6A

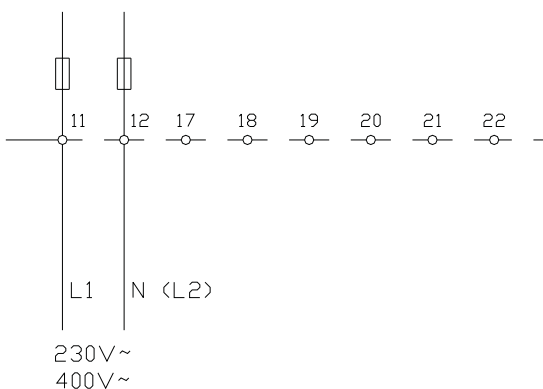

Note: Observe the respective type plate.
Control voltage XXX



Classic P3 x/x - 240-840A

Power supply

Direct power connection

Connection

Phase	L1	bolt X10:16
Phase	L2	bolt X10:15
Phase	L3	bolt X10:14

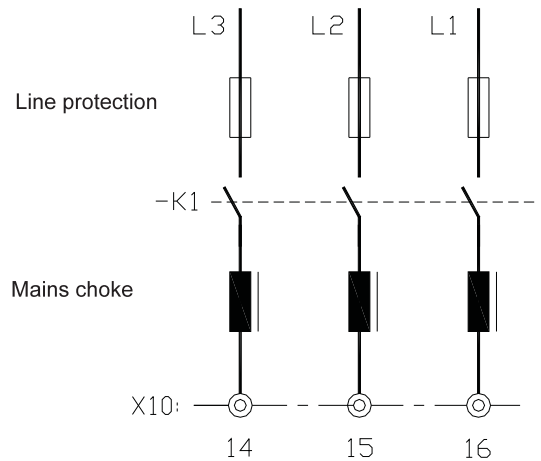

Note: L1, L2, L3 - clockwise rotating field
Protecting earth - PE connection

Unit P3 Type current	Power choke KD-three-phase current K-phase choke	Fuses A super fast acting installed
240	KD 5-250	3x250 A FF
360	K 170-400	3x315 A FF
480	KU 150-600	3x400 A FF
840	KU 150-800	3x500 A FF

Power connection with an auto-transformer

Transformer performance
1.1 x continuous motor power

Secondary voltage
0.9 x motor power

Transformer fuses
Slow acting
Observe the switch-on current!!!

Input fuses F1, F2, F3
rf. to the table above

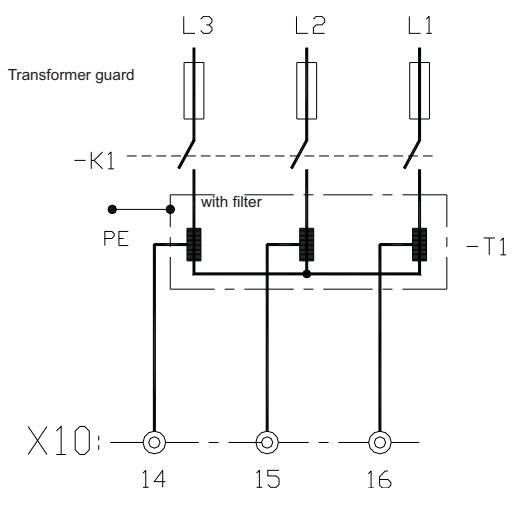

Attention:
If the secondary voltages produced by the transformer are inferior to 60% the voltage watchdog has to be adapted. These modifications may only be effected in the factory and thus, the voltages have to be indicated on order.



Watchdog power connection
BTB inactive dark LED >>> missing phase
 >>> wrong rotating field

3 Electrical Installation

Option - External synchronization

For special applications it might be necessary to tap the synchronization before the power commutating choke, e.g

- when operating via field triggering circuit
- in case of an instable power supply

When changing to external synchronization, the 3 resistors 0W (R15, R34, and R40) on the board 'Q3 - on3' have to be removed.

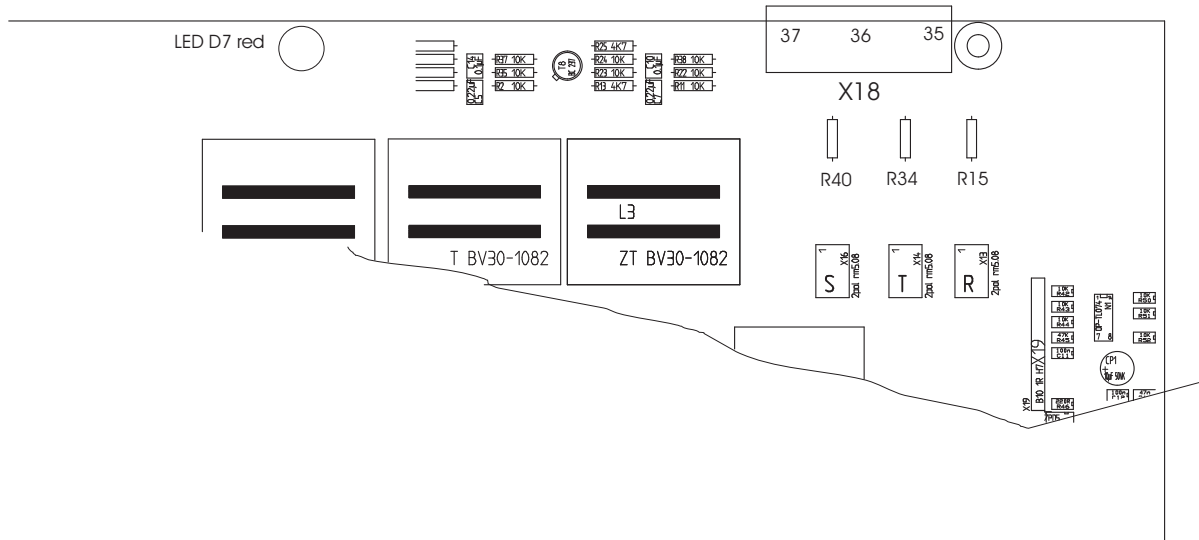

Connections

Connection across the terminals X18:35, 36, 37

Observe the phase position!

- L3 across X10:14 (via power choke) and directly across terminal X18:36
- L2 across X10:15 (via power choke) and directly across terminal X18:37
- L1 across X10:16 (via power choke) and directly across terminal X18:35

The wiring has to be short-circuit proof or protected by means of a line protection.

The phase position function has a watchdog and in case of wrong connections the LED D7 on the board Q3-on3 will light and the BTB signal on the controller extinguishes when the controller is enabled.

LED D7 also lights if there is a breakage of the installed fuses.

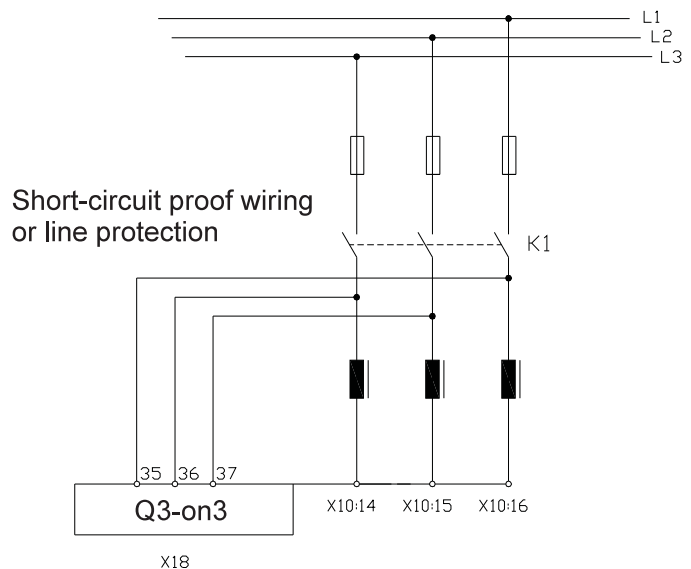

Free



3 Electrical Installation

Motor connection

Connection

positive command value

Motor- bolt X10:13

Motor+ bolt X10:10

Note:

Armature choke only for a few applications

Inductance: $L \text{ [mH]} = U/I \times 0.8$

Standard version without a choke

Motor lines have to be shielded.

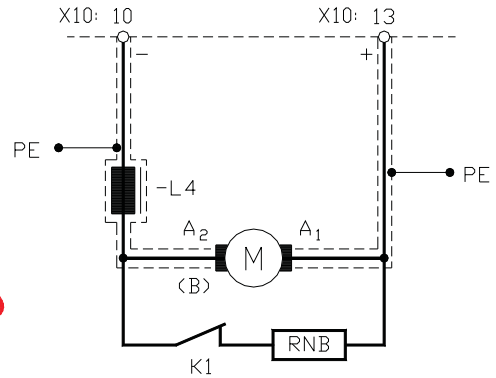

Unit P3 x/x- Type current	Choke * Direct current	Min. Conductor cross-section (mm ²)
240	UI180B250	70
360	UI210C400	150
480	UI240C500	240
840	UI240-7000	500

* Chokes are necessary only for special applications, e.g. quiet motor operation (stage technique)



Switching in the armature circuit

- dc circuit current-free
- disable inactive

Warning:

Faulty switching will create arcing across the switch contacts.

Power supply failure - brake resistor

Break contact of the mains contactor K1

Rating: Resistor RNB = max. armature voltage/2 x type current



Attention:

Power lines have to be shielded and routed separately from control lines!
For electro-magnetic interferences please refer to the CE advice.

Classic P3 x/x - 240-840A

Constant field Connection		Plug-in terminal connectors
Input		X5:17, X5:18
Field	negative	X5:19
Field	positive	X5:20
Signal contact		X5:21, X5:22
Field voltage		Field supply
Power supply		210V=
230V~		360V=
400V~		0.9 x transformer secondary voltage
Variable with auto-transformer		
Field current		max. 10A=
Internal fuses		2 x 10AF
Cross-section -connecting line		min. 0.5mm ²
External protection		line protection, min. 10A

Field current watchdog	
Operating current	700mA
Signal contact	48V/0.5A
Connection	X5:21, X5:22
Error	open contact

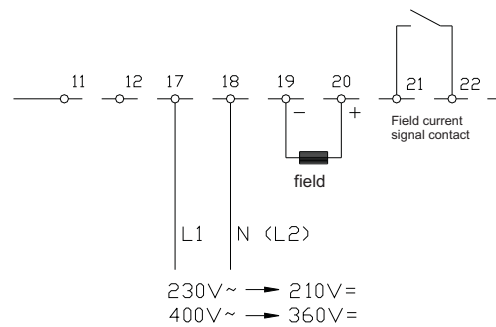

Controlled field
Optional field current controller P3-F
 Observe Manual P3-F

Field current control	
Field voltage	max. 320V=
Control range	200mA to 10A

Combination of field/armature control
Field triggering circuit

Internal potential-free armature voltage measuring	
Field voltage	max. 320V=
Control range	200mA to 10A
Triggering point U	max. 450V=
Adjustments	min./max. field current control parameter

EMC: for a controlled field >>> use shielded field lines

3 Electrical Installation

Tacho

Suitable actual value encoders:

DC tacho generator

Brushless tacho generator with evaluation electronics

Incremental encoders with evaluation electronics

AC or three-phase tacho with rectification

Connection

Control electronics (see Manual REG)

In case of a positive command value

Tacho positive	X 1:8b
Tacho negative	X 1:9
Shield	X 1:8

Armature voltage

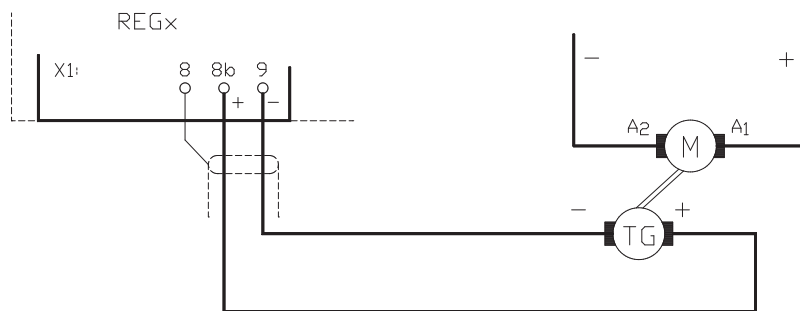

Ground referenced actual value

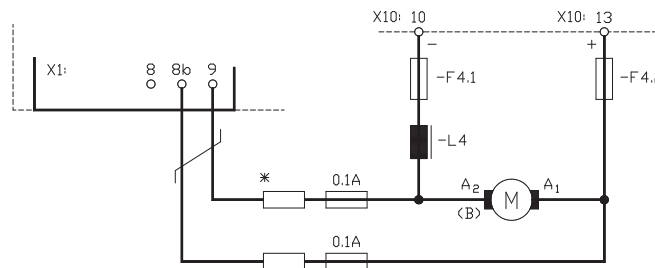

* only by U_n > 180V

Fuses 2x 0.1A directly in the armature circuit
For armature voltage > 180V= additional resistors are required

Use unit UNITEK EXZU-UA1 (The suitable unit EXZU-UA comprises 2 fuses and 2 resistors in an insulated housing.)

Note: Observe Manual REGxx

Option: In case of internal potential-free armature voltage control please indicate on order.



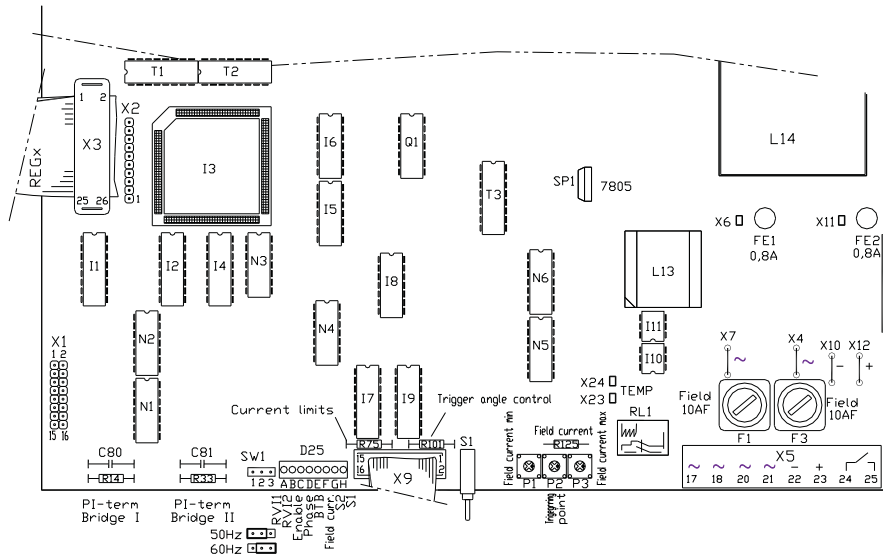

Adjustments

Variable elements

Variable elements	Function	Range
R33	P-amplification current controller 2	18kΩ to 470kΩ
R75	Exact adjustment - current limit	100kΩ to 470kΩ
R101	Trigger angle control	240kΩ to 560kΩ
R125	Field current	
C81	Integral term - current controller 2	0.1μF to 2.2μF

Potentiometer

P1	min. field current	0 to 15%
P2	Triggering point for armature/field control	200 to 450V
P3	max. field current	0 to 100%

Jumper

SW1 Pos.1-2	50Hz adjustment
SW1 Pos.2-3	60Hz adjustment

Switch

S1	Reset
----	-------

LED displays

D25A	Current control loop RVI-1	control active
D25B	Current control loop RVI-2	control active
D25C	Enable	enabled
current controller/triggering		
D25D	Phase error	error
D25E	BTB ready	operational
D25F	Field current	luminous intensity = field current
		(only for a controlled field)
D25G	Current flow direction S2	active
D25H	Current flow direction S1	active

3 Electrical Installation

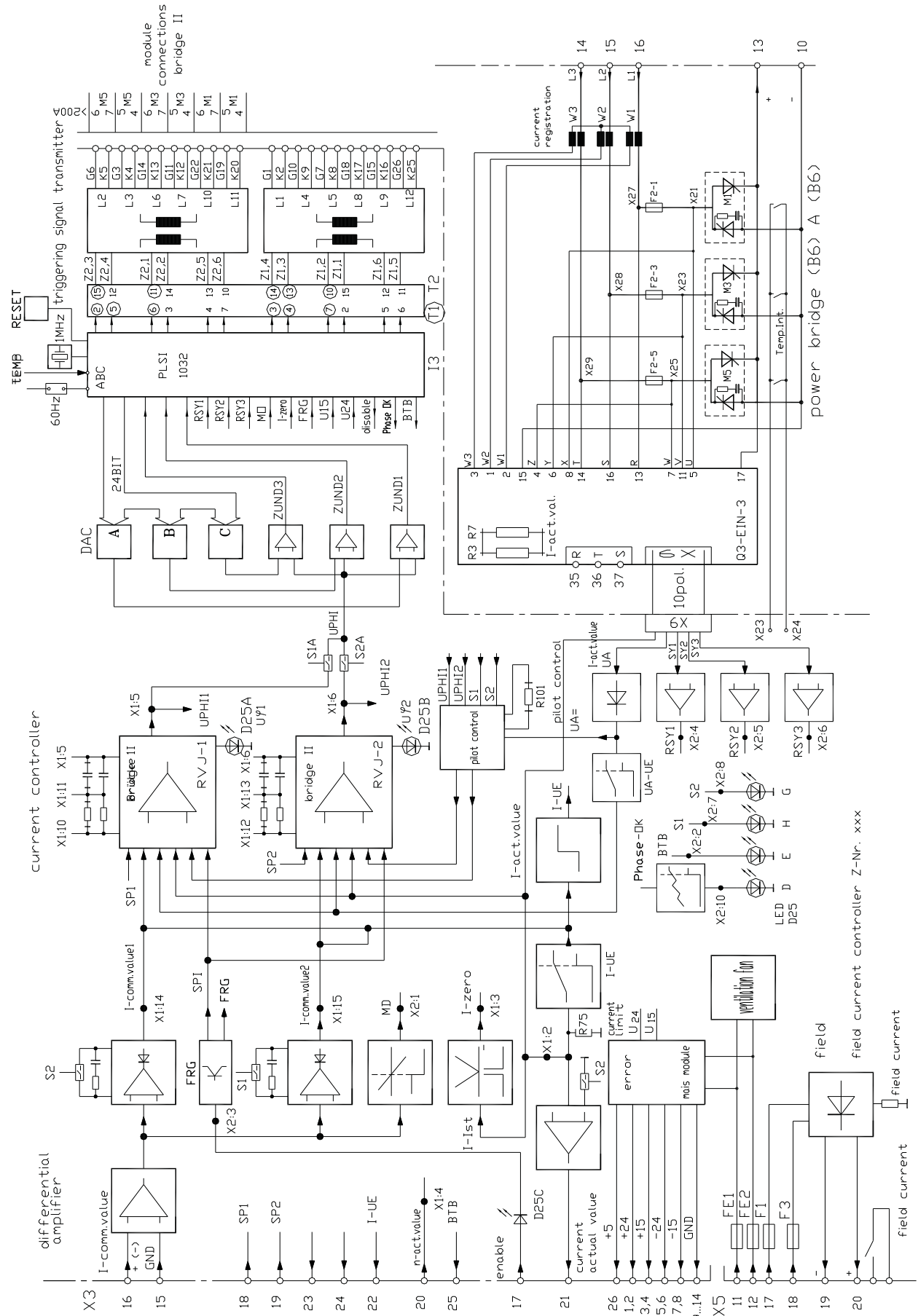

Current controller - PI loop circuit

for a positive command value
 Bridge 2 positive R33, C81

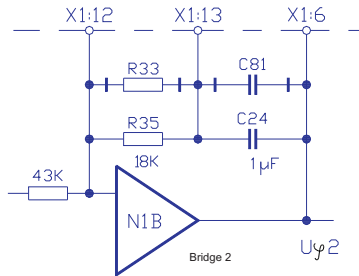
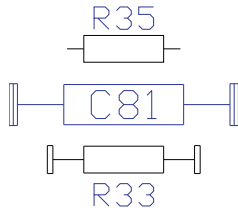

Basic set-up

Amplification ~1.1

Integration time ~15ms

Changing the amplification

Bridge 2:

$$X_P = \frac{18k\Omega \times R_{14}}{18k\Omega + R_{14}} \times \frac{43k\Omega}{43k\Omega}$$

Changing the integration time

Bridge 2:

$$\tau_{[ms]} = \frac{18k\Omega \times R_{33}}{18k\Omega + R_{33}} \times 1\mu F + C_{81}$$

Optimization of the current controller

- Connect an oscilloscope across the current actual value X3:21
- Current command value step-change ±1V X3:16
- Increase the current command value by 1V steps to ±10V
- Alter the P-amplification by means of the resistor R33
- Optimal adjustment see fig. 1
- Not permissible adjustment see fig. 2
- Alter the integral part by means of the capacitor C81

Oscilloscope - Current adjustment

Fig. 1

Fig. 2

Fig. 3

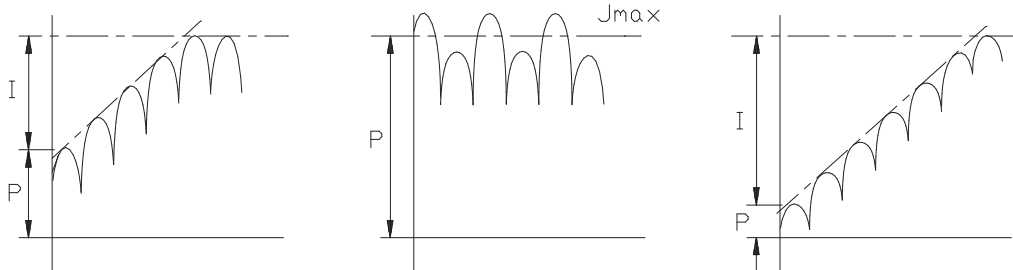

Note: Any changes in the optimization of the current controller must be checked by means of an oscilloscope.



3 Electrical Installation

BTB signal - Drive ready

BTB signal X3:25 > +5V
 Error X3:25 < +5V

Error

Voltage error	24V, 15V, 5V	saved
Phase error, rotating field		saved
Defective input fuse		saved
Over-temperature		saved

In case of errors or failure the power section is immediately internally disabled without delay.

To clear the saved error re-enable the drive (switch off/on or reset key)

Measurements

Measurement advice

Measuring instruments: multimeters for current and voltage
 shunt or clamp-on ammeter
Measuring faults: mean value > actual value
 acc. to the form factor
 approx. 1 to 5%

Measured values

with a positive command value

Voltage: X10:10 negative X10:13 positive
 max 1.15 x power supply
 For 400V~ >>> 460V=

Current: ammeter in the motor circuit
 5s 200%, continuously 110% type current

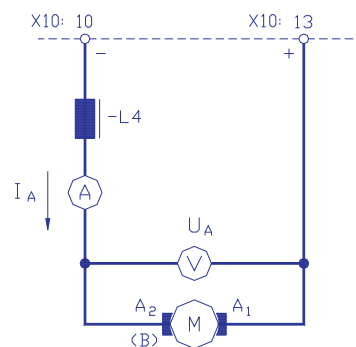

Measured values across REG4
 (selectable, see Manual REG4)

Speed X2:109 -5V or -10V for 100% speed
Current X2:111 -5V or -10V for 200% current
GND X2:104

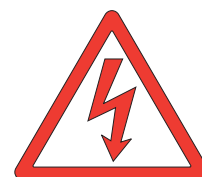

Commissioning P3 x/x-x with REG4

Check the following connections before commissioning
Observe the type plate!



Basic connection - power connections P3

Power supply	power	bolts X10:14, X10:15, X10:16
Power supply	auxiliary voltage	terminals X5:11, X5:12
Power supply	field	terminals X5:17, X5:18
Motor connection	A1/A2	bolts X10:10, X10:13
Field connection	F1/F2	terminals X5:19, X5:20
Field current signal		terminals X5:21, X5:22
Protecting earth	PE	earthing screws PE on the housing

Control connections

Enable	contact between X1:3 and X1:4	
Command value	signal X1:6, GND X1:8a	
Actual value	signal X1:9, GND X1:8b	
Shields	X1:8	

Control electronics REG4

Switch	S4	PI amplification	position 4
Switch	S5	I-term	position 4
Switch	S8	D amplification	position 8
Switch	S9	actual value	position 8
Potentiometer	I1	peak current	10%
Potentiometer	I2	peak current	10%
Potentiometer	ID	continuous current	100%
Potentiometer	Xp	amplification	50%
Potentiometer	INT	integrator	left full scale
Potentiometer	n _{max}	speed	left full scale
Potentiometer	offset	offset	50%

4 Commissioning

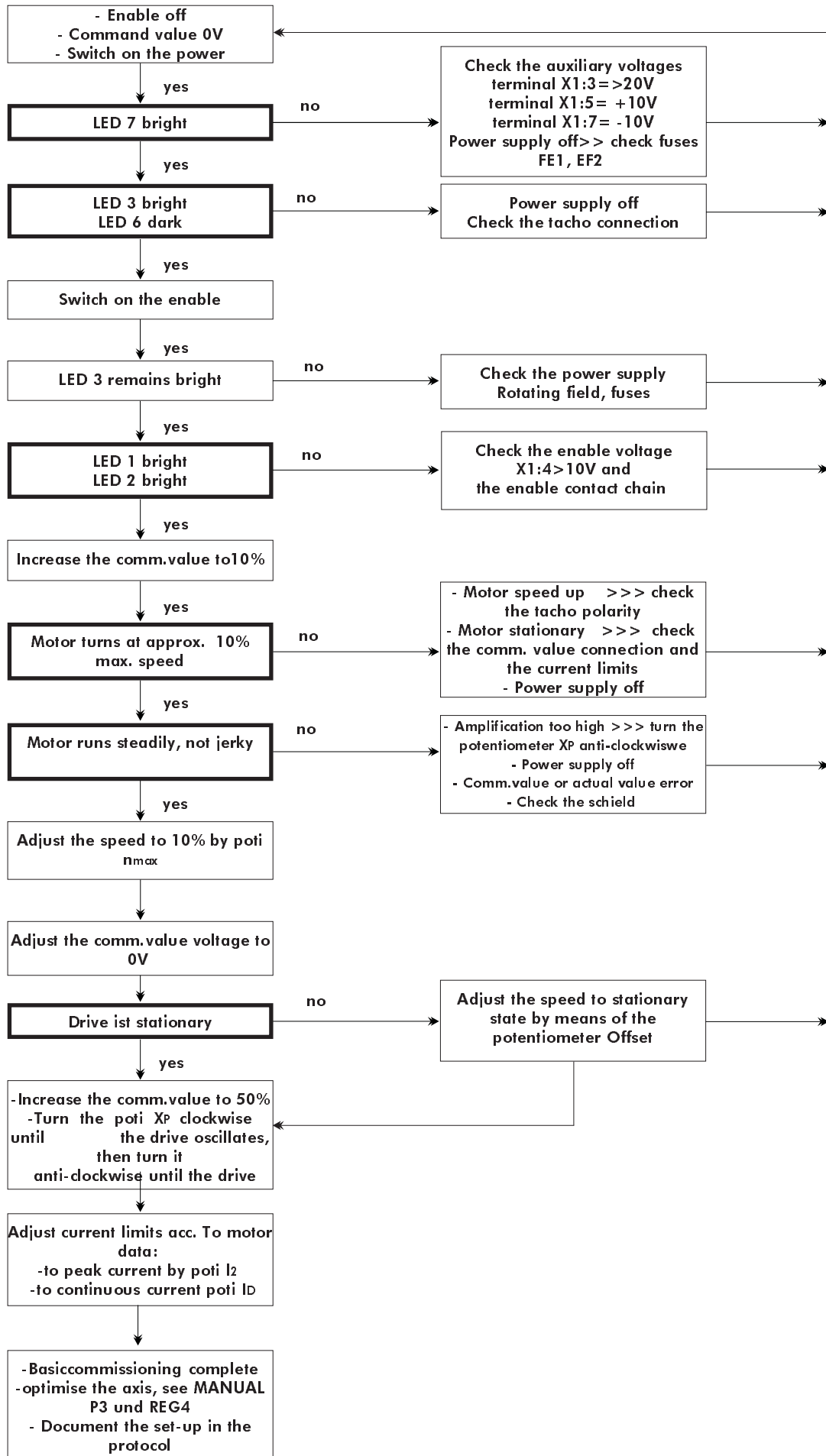

Classic P3 x/x - 240-840A

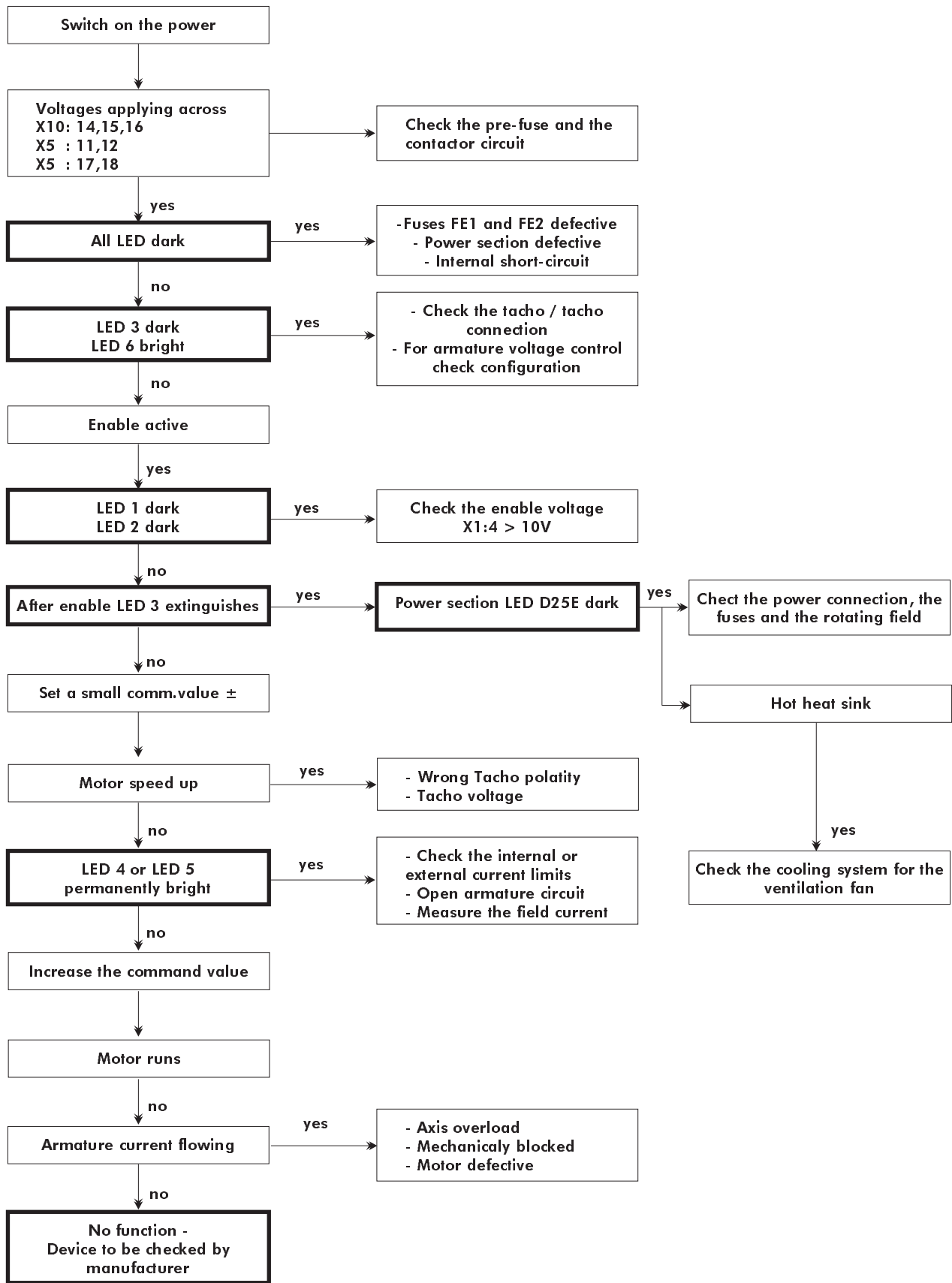

5 Error diagnosis

Malfunction	Causes
Motor does not run	<ul style="list-style-type: none"> - Wrong power supply and motor connections - Activated fuses - Missing enable or command value - Current limit too low - Missing BTB
Motor speeds up	<ul style="list-style-type: none"> - Wrong polarity of the actual value (tacho) - Values of the tacho switch S9 too low - Command value too high <p>For armature voltage control</p> <ul style="list-style-type: none"> - Field current too low - Fuses, armature voltage feedback activated
Motor runs unsteadily	<ul style="list-style-type: none"> - Mechanical defect of the tacho - Tacho malfunction - Amplification of the speed controller too low or too high - Wrong PID parameter - Command value errors - Amplification of the current controller too low or too high
No motor torque	<ul style="list-style-type: none"> - Current limits too low - Field current too low - Mechanical overload of the axis

Guarantee

UNITEK guarantees that the device is free from material and production defects. Test results are recorded and archived with the serial number.

The guarantee time begins from the time the device is shipped, and lasts two years. Unitek undertakes no guarantee for devices which have been modified for special applications.

During the warranty period, UNITEK will, at its option, either repair or replace products that prove to be defective, this includes guaranteed functional attributes. UNITEK specifically disclaims the implied warranties or merchantability and fitness for a particular purpose. For warranty service or repair, this product must be returned to a service facility designated by UNITEK.

For products returned to UNITEK for warranty service, the Buyer shall prepay shipping charges to UNITEK and UNITEK shall pay shipping charges to return the product to the Buyer.

However, the Buyer shall pay all shipping charges, duties, and taxes for products returned to UNITEK from another country.

The foregoing warranty shall not apply to defects resulting from:

- * improper or inadequate repairs effected by the Buyer or a third party,
- * non-observance of the manual which is included in all consignments,
- * non-observance of the electrical standards and regulations
- * improper maintenance
- * acts of nature

All further claims on transformation, diminution, and replacement of any kind of damage, especially damage, which does not affect the UNITEK device, cannot be considered. Follow-on damage within the machine or system, which may arise due to malfunction or defect in the device cannot be claimed.

This limitation does not affect the product liability laws as applied in the place of manufacture (i. e. Germany).

UNITEK reserves the right to change any information included in this MANUAL.

All connection circuitry described is meant for general information purposes and is not mandatory.

The local legal regulations, and those of the Standards Authorities have to be adhered to. UNITEK does not assume any liability, expressively or inherently, for the information contained in this MANUAL, for the functioning of the device or its suitability for any specific application.

All rights are reserved.

Copying, modifying and translations lie outside UNITEK's liability and thus are not prohibited. UNITEK's products are not authorised for use as critical components in the life support devices or systems without express written approval.

The onus is on the reader to verify that the information here is current.

7 Protocol

Protocol

P3 x/x-x with REG4

Customer Machine No.

Device P3- Serial No

Control voltage [V~]

Power supply voltage [V~]

Field voltage [V=]

Inputs REG4

Enable	contact ?	voltage [V=]
Command value	type	voltage [V=]
Command value, additional	type	voltage [V=]
Current command value	I _{max2} external	voltage [V=]

Speed controller settings REG4

Switches

Tacho adjustment	S9	Position
P-term	S4	Position
I-term	S5	Position
D-term	S8	Position

Potentiometers

Speed	n _{max}	P4	Position
Peak current	I _{max1}	P5	Position
Peak current	I _{max2}	P6	Position
Continuous current	I _D	P7	Position
Integrator	INT	P1	Position
Amplification	X _P	P3	Position
I _x R compensation		P2	Position

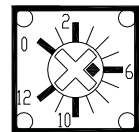
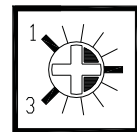

DIP switch

on no.

off no.

